



Assembly Instructions

ITEM # WOP001-5/WOP002-5 (Cherry/Oak)







Remmington Bookcase- Cherry-72 Inches



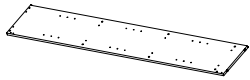
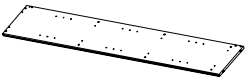
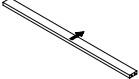



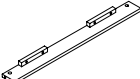

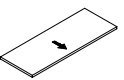

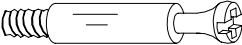
Remmington Bookcase- Oak-72 Inches

PRE-ASSEMBLY PREPARATION:

Please check all contents of this package before attempting to assemble the product. A full checklist of components is provided. If any components are missing, please contact the retailer from whom you have purchased this product. Read the Assembly Instructions in full before you begin to assemble. Please use **CAUTION AND CARE WHEN LIFTING** the product to avoid personal injury and (or) damage to the product. For ease of assembly, two people are recommended. The hardware packet contains **SMALL ITEMS** which should be **KEPT AWAY FROM CHILDREN**.

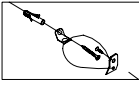
Hardware and Panel Identification List:

| | PARTS | Q' TY |
|---|-------------------------------------------------------------------------------------|-------|
| A |  | 1PC |
| B |  | 1PC |
| C |  | 1PC |
| D |  | 1PC |
| E |  | 2PCS |
| F |  | 1PC |
| G |  | 1PC |
| H |  | 1PC |
| I |  | 3PCS |

| | | |
|----|---------------------------------------------------------------------------------------|-------|
| 1 |  | 18PCS |
| 2 |  | 18PCS |
| 3 |  | 22PCS |
| 4 |  | 38PCS |
| 5 |  | 12PCS |
| 6 |  | 4PCS |
| 7 |  | 2PCS |
| 8 |  | 2PCS |
| 9 |  | 1PC |
| 10 |  | 18PCS |
| 11 |  | 4PCS |

Step By Step Assembly Instructions

Step 1:

- 1.1, Have the intended components being ready to proceed as shown in this step.
- 1.2, Screw Cam-shaft (1) and insert Dowel (3) to the side panel (A).
- 1.3, Fix the metal jointer (7) on Stretcher (C) with screw (11).
- 1.4, Place Cam-lock(2) in concern holes as shown
- 1.5, Assemble panel (D/E/F) and stretcher (C/G) to side panel (A). Secure panels with Cam-lock (2) by using Allen Key (9) clockwise. Then cover exposed hole with cap (10).

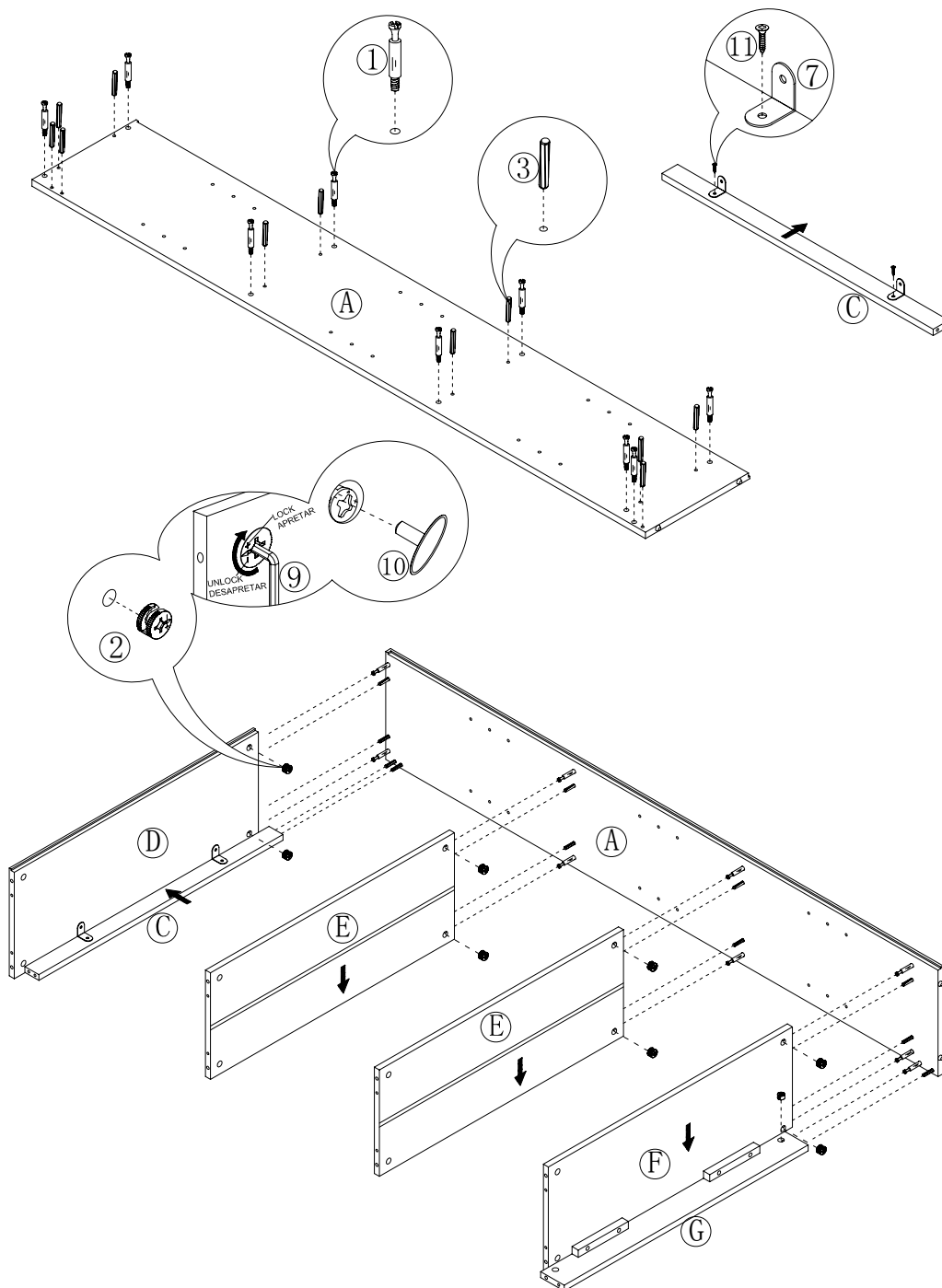

Step 2:

- 2.1, Have the intended components being ready to proceed as shown in this step.
- 2.2, Screw Cam-shaft (1) and insert Dowel (3) to the side panel (B).
- 2.3, Fix stretcher (C) on panel (D) with screw (11).
- 2.4, Place Cam-lock(2) in concern holes as shown
- 2.5, Assemble panel (D/E/F) and stretcher (C/G) to side panel (B). Secure panels with Cam-lock (2) by using Allen Key (9) clockwise. Then cover exposed hole with cap (10).

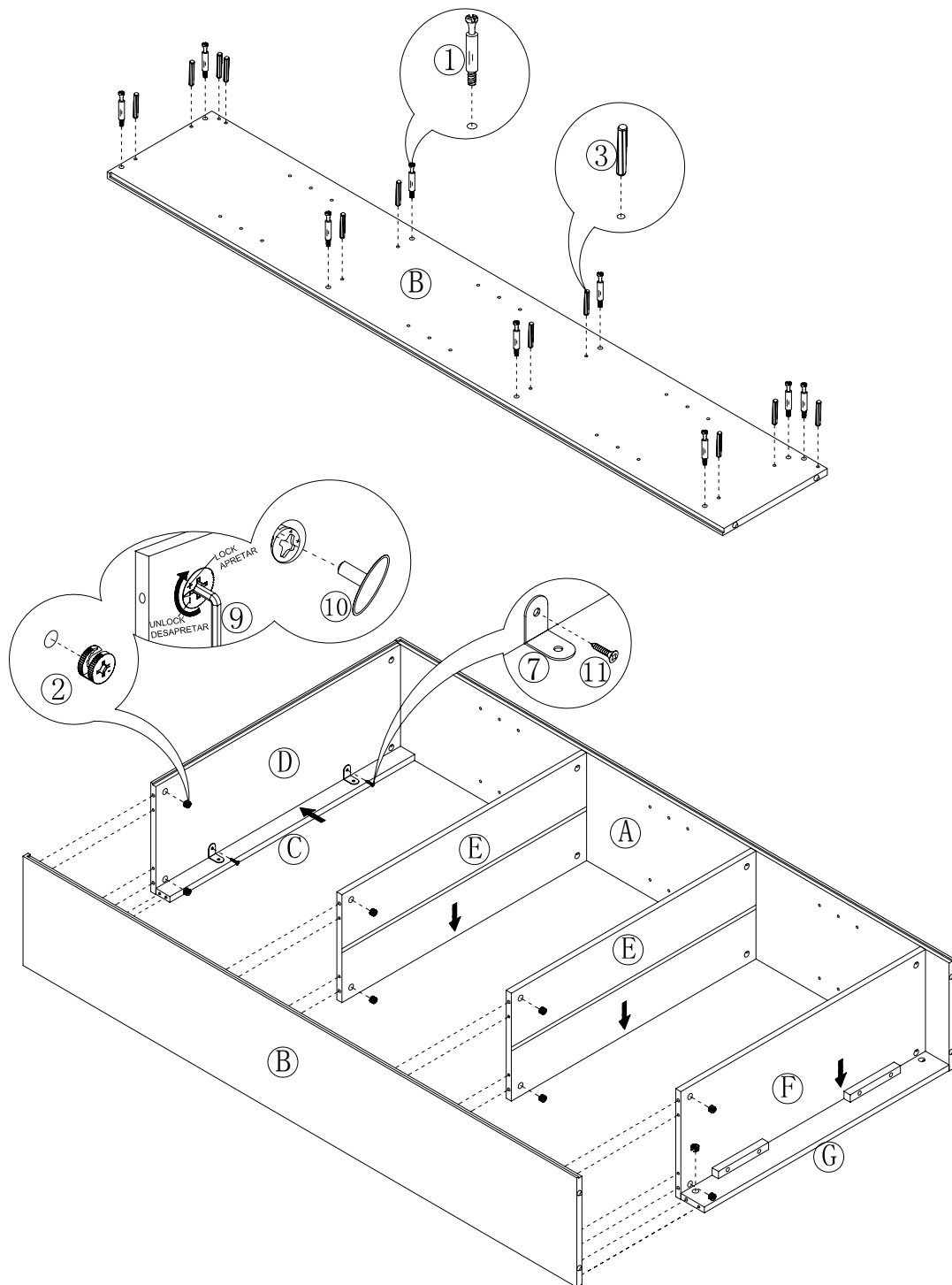

Step 3:

- 3.1, Have the intended components being ready to proceed as shown in this step.
- 3.2, Place back panel (H) on main base, then fix back panel on main base with screw (4).
- 3.3, Fix stretcher (G) on panel (F) with screw (6).

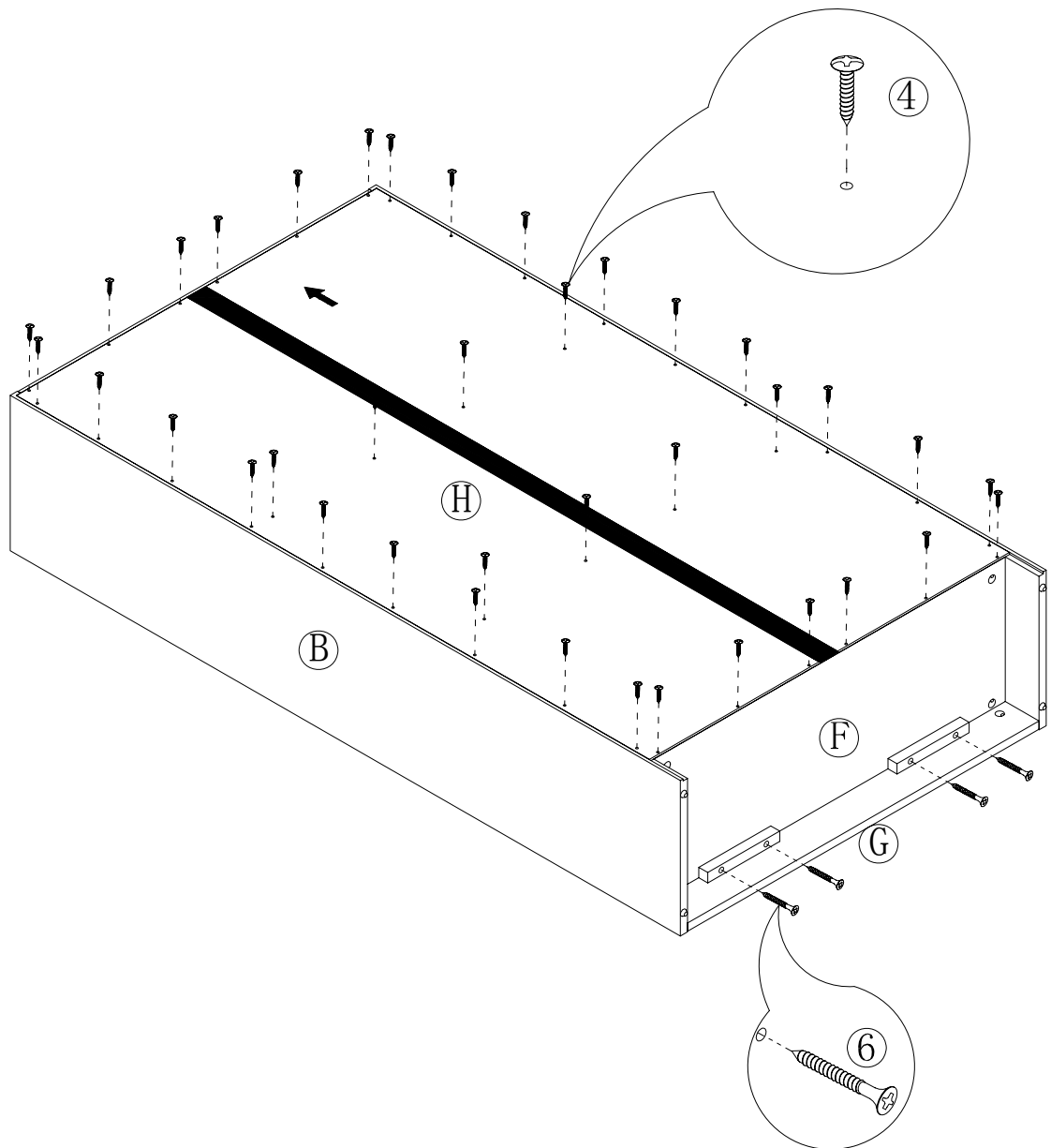

Step 4:

4.1, Have the intended components being ready to proceed as shown in this step.

4.2, Insert shelf holder (5) to both side panel (A/B)

4.3, Place shelf (I) on shelf holder (5) according to arrow direction

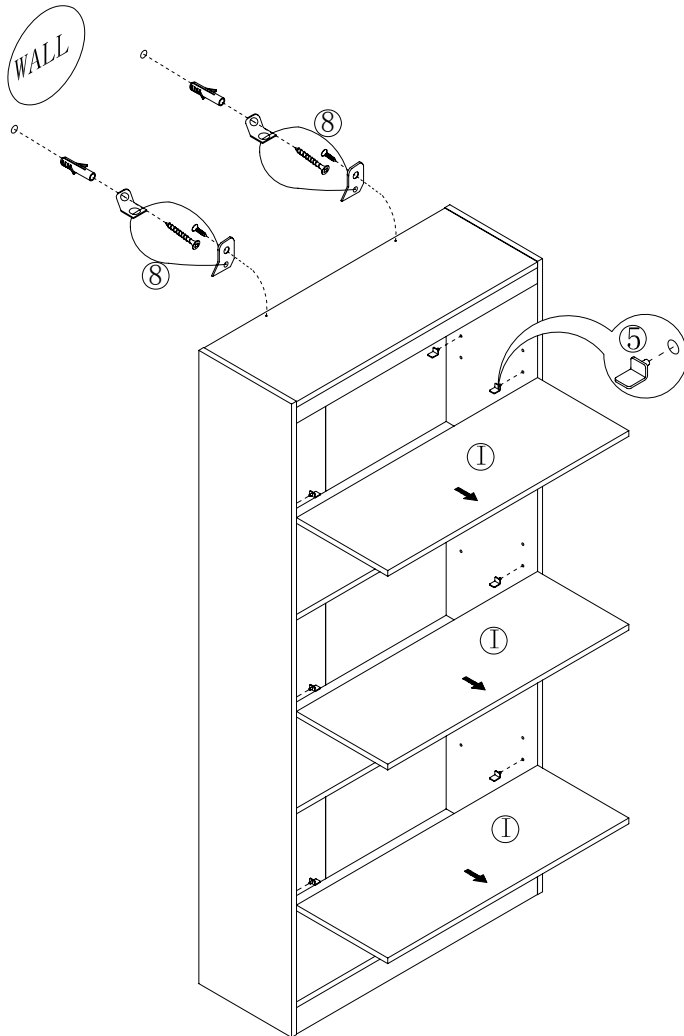

Assembly Instruction for Anti-Tipping Kit

1. Attach one of the mounting brackets near the top back edge of the furniture piece and insert the shorter screw.
2. Mark location on the wall approximately 2" below the bracket mounted to the back of the furniture.
3. Drill a starter hole into a wall stud and insert plastic anchor, and gently tap the anchor until the flange of the anchor is flush with the wall.
4. Attach the second bracket by inserting the longer screw through the bracket and into the wall.
5. Place the furniture so the bracket on the back edge is in line with the bracket on the wall.
6. Lace the end of the nylon restraint strap down through each bracket. Bring both ends together and slide the beaded end until it snap locks into the keyhole slot.
7. Make sure the strap is securely laced and locked to the brackets.

Complete. Your brand new Bookcase is ready to use now.